

---

## BuzziNest Booth Product Specification Sheet

---

This document contains technical  
information about the BuzziNest Booth

---



[www.buzzi.space](http://www.buzzi.space)

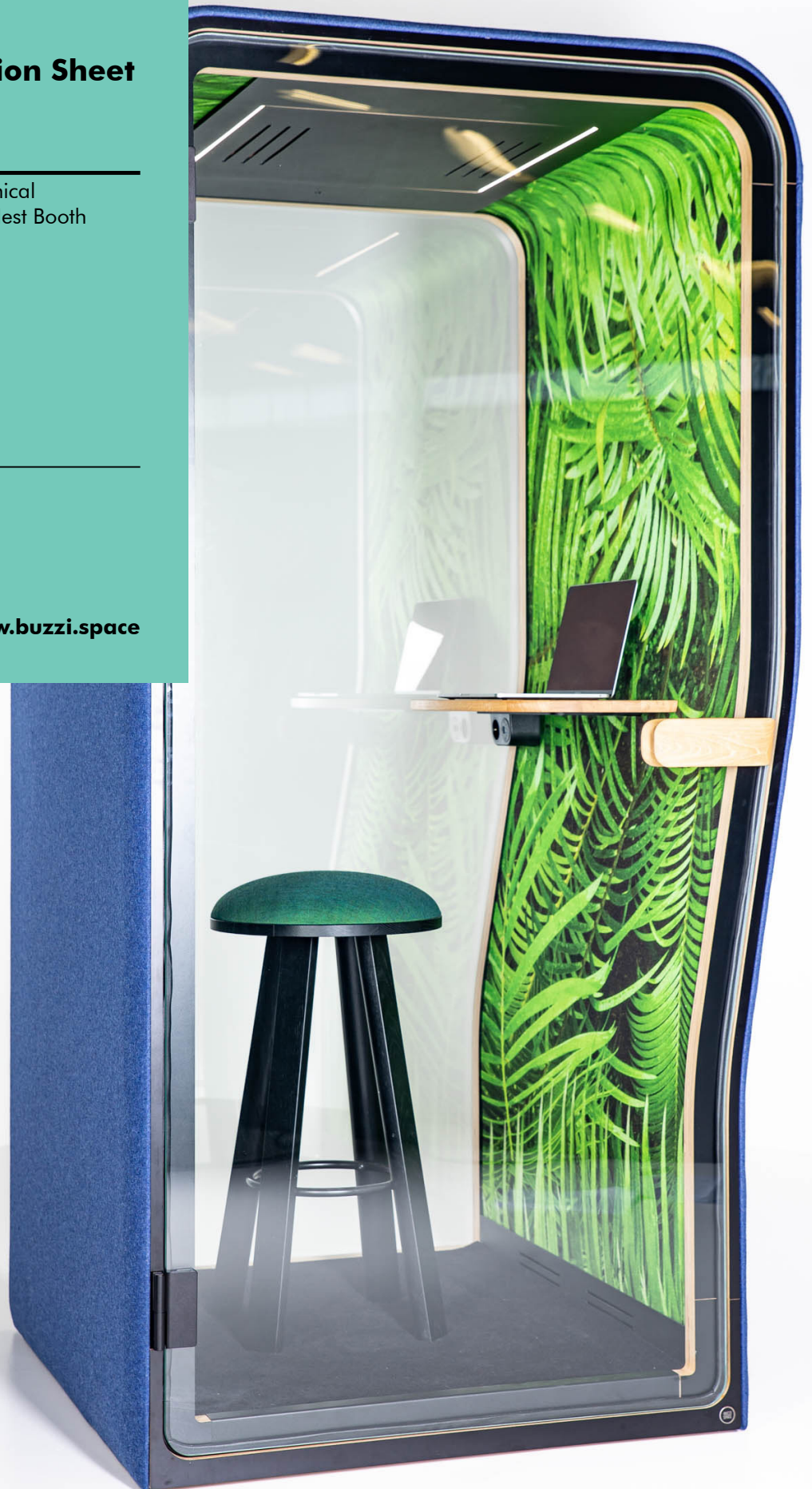

## Silent workspaces anywhere





BuzziNest Booth is all you need to erase distracting noise from any workplace. The compact acoustic privacy booth for one offers a private space to work and take calls in any open space without disturbing others, and most importantly, being disturbed. Due to its upholstered exterior and fabric panels on the interior, BuzziNest Booth effectively dampens sound from every direction to create maximum peace and quiet for everyone in the office, whether you are working inside BuzziNest Booth or out.

BuzziNest Booth is also customizable with high-quality materials and furniture. Choose from a wide range of fabrics, frames, door openings, shelf and table finishes, seating options, and table heights. The mobile BuzziNest Booth can easily fit into an existing space and comes fully packaged with a top-of-the-line motion sensor fresh air ventilation system, automatic LED lighting system, main power outlet (230V), and two USBs (A+C).

Design by BuzziSpace Studio

---

## General

-  BuzziNest Booth
-  Structure: Laminated poplar plywood with visible trim
-  Cover: Inside: Felt, Felt Printed or 3D pattern in Fabric or Trevira CS+  
Outside: Fabric covered foam with Fabric or Trevira CS+
-  Flat Packed  
Installation time 1 to 1,5 hours, including unboxing
-  Optional Shelf with electrification  
Milk Bar

---

## Acoustics



---

## Certifications



---

## Content

Configurations	3	Finishes	9
Components	4	Dimensions	10
Fabrics	8	Acoustics	12

# Configurations

---

## BuzziNest Booth

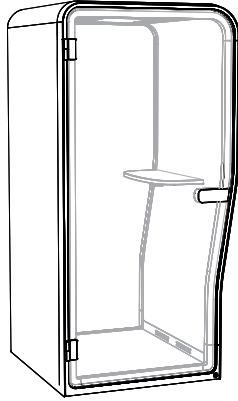

- 🔑 BuzziNest Booth  
Left or right handed
- 🌲 Structure: Laminated poplar plywood with visible trim  
Cover: Inside: Felt, Felt Printed or 3D pattern in Fabric or Trevira CS+  
Outside: Fabric covered foam with Fabric or Trevira CS+

### Power:

Mains supply: 230V, 50 Hz, max 10A

Stand-by consumption: 1,15W

Consumption when in use: 16,75W

- 🔌 Internal fuses: 2 x 10A glass fuses (5 x 20mm, speed T)

### Output:

Table socket – 230V, 50Hz, max 6A

Twin USB charger – type A and C, max 5A at 5VDC combined

### Lighting unit:

Power usage: 14W

Input: 230V / 50Hz

Lumen output: 1260 lumen

Color Temperature: 4000K

Color Rendering Index: >80



### Ventilation unit:

Power usage: 2,88W

Input: 12V dc

Airflow rate when occupied: 10l/s

Airflow rate after 5 mins no occupancy: 5l/s

Airflow rate stand-by mode, after 15 mins no occupancy: 2l/s



### Installed

Length: 110 cm | 43.3"

Height: 218 cm | 85.8"

Width: 107 cm | 42.1"



### Packaged (1 palletized crate)

Length: 222 cm | 87.4"

Height: 125 cm | 49.2"

Width: 79 cm | 31.1"



310 kg | 683 lbs

406 kg | 895 lbs



Optional Shelf with electrification  
Milk Bar

# Components

---

## Outside

The outside shell is available in Fabric, Trevira CS+



Fabric



Trevira CS+

---

## Inside

The inside cover is available in Felt, Felt Printed, Fabric\* or Trevira CS+\*  
(\*only in combination with 3D Rib)



Felt



Felt Printed



3D Rib Fabric/ Trevira CS+

---

## Floor Cover

The floor cover is always in black carpet.



---

## Frame

Frame is available in Laminated plywood White, Black or Truffle Grey



White



Black



Truffle Grey

---

## Door Handle

Material: Oak with inlay in same color as frame



---

## Shelf including electrification (optional)







Shelf in Oak or Laminated plywood White, Black or Truffle Grey

Mains power outlet and 2 USB chargers (type A and C) max 5A at 5VDC combined

When the BuzziNest is selected without shelf containing electrification, a Wieland connector is foreseen underneath the carpet to accommodate a 3rd party electrification unit.



Available for:

-  NL|DE|LUX
-  BE|FR
-  UK
-  AUS
-  CH
-  CN

---

## Lighting



Integrated LED Light  
Power usage: 14W  
Input: 230V / 50Hz  
Lumen output: 1260 lumen  
Color Temperature: 4000K  
Color Rendering Index: >80

---

## Ventilation



For healthy air circulation there is a integrated ventilation. Cutout for sprinkler possible.  
(please reach out to customer service for instructions)

Power usage: Max. 2,88W  
Airflow rate:  
- when occupied: 10l/s  
- after 5 mins no occupancy: 5l/s  
- stand-by mode, after 15 mins no occupancy: 2l/s

---

## Power Connection

You can choose where to connect the power supply: at the side or on top.  
Selecting the proper power inlet can be done by a switch situated behind the internal acoustic panels.

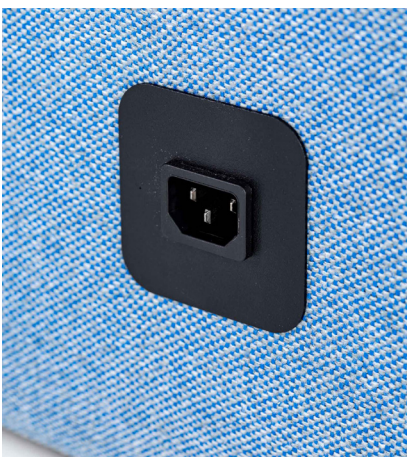

---

## Wheels



The BuzziNest Booth is moveable by the 4 wheels underneath. Floor adjusters are integrated for leveling.

---

## Orientation



Left handed



Right handed

---

## BuzziMilk Bar (optional)



The BuzziMilk Bar is the ideal stool to have in the BuzziNest Booth. More info [Buzzi.Space](https://www.buzzi.space)

# Fabrics

## Felt

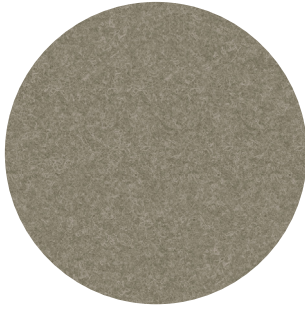

**Composition** 100% Recycled P.E.T. Felt, latex backing  
**Weight** 1.000 g/m<sup>2</sup> | 29.49 oz/yd<sup>2</sup>  
**Abrasion resistance** >7.000 Martindale  
**Flammability** EU: EN 13501.1 + A1/2009 Class B-s1,d0  
USA: ASTM E84 Class A certified  
**Fastness to light** USA 5



## Printed Felt



**Composition** 100% Recycled P.E.T. Felt, latex backing  
**Weight** 1.000 g/m<sup>2</sup> | 29.49 oz/yd<sup>2</sup>  
**Abrasion resistance** >7.000 Martindale  
**Flammability** EU: EN 13501.1 + A1/2009 Class B-s1,d0  
USA: ASTM E84 Class A certified  
**Fastness to light** USA 5



## Fabric

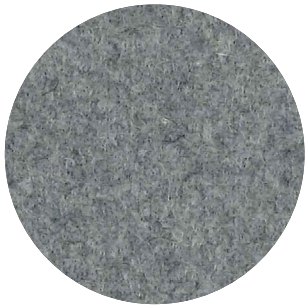

**Category A**  
**Composition** 70% Recycled Wool, 25% Recycled Polyacryl,  
5% Recycled Other Fabrics  
**Weight** 405 g/m<sup>2</sup> | 11.94 oz/yd<sup>2</sup>  
**Abrasion resistance** 40.000 Martindale, 50,000 Wyzenbeek  
**Flammability** EU: EN 1021.1/2006 | BS EN 1021.1/2006 (cigarette).  
EN 1021.2/2006 | BS EN 1021.2/2006 (match)  
USA: CAL TB 117 | ASTM E84 CLASS A  
**Fastness to light** EU: 4 | USA 4  
**Fastness to rubbing** EU: Wet 3-4 | Dry 4-5  
**Fastness to crocking** USA: Wet 5 | Dry 5



## Trevira CS+ | CS

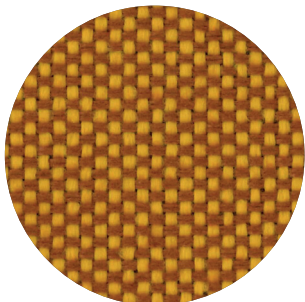

**Category A**  
**Weight** 420 g/m<sup>2</sup> | 12.39 oz/yd<sup>2</sup>  
**Composition** 100% Polyester, Trevira CS  
**Abrasion resistance** 100.000 Martindale, 90,000 Wyzenbeek  
**Flammability** BS 5852 part II: CRIB 5 | BS 7176 Medium Hazard  
USA: CAL TB 117 | M1 | B1 | EN 1021/1-2 | C1 |  
IMO Res. A652 (16)  
**Fastness to light** EU: 6 | USA 5  
**Fastness to rubbing** EU: Wet 4-5 | Dry 4-5  
**Fastness to crocking** USA: Wet 5 | Dry 5





# Finishes

---

## Laminated Plywood with visible lining

Frame and shelf



White



Black

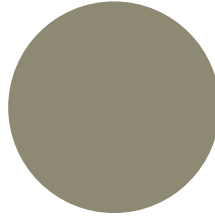

Truffle Grey



PlyWood lining

---

## Wood

Door handle and shelf



Oak

# Dimensions

## BuzziNest Booth

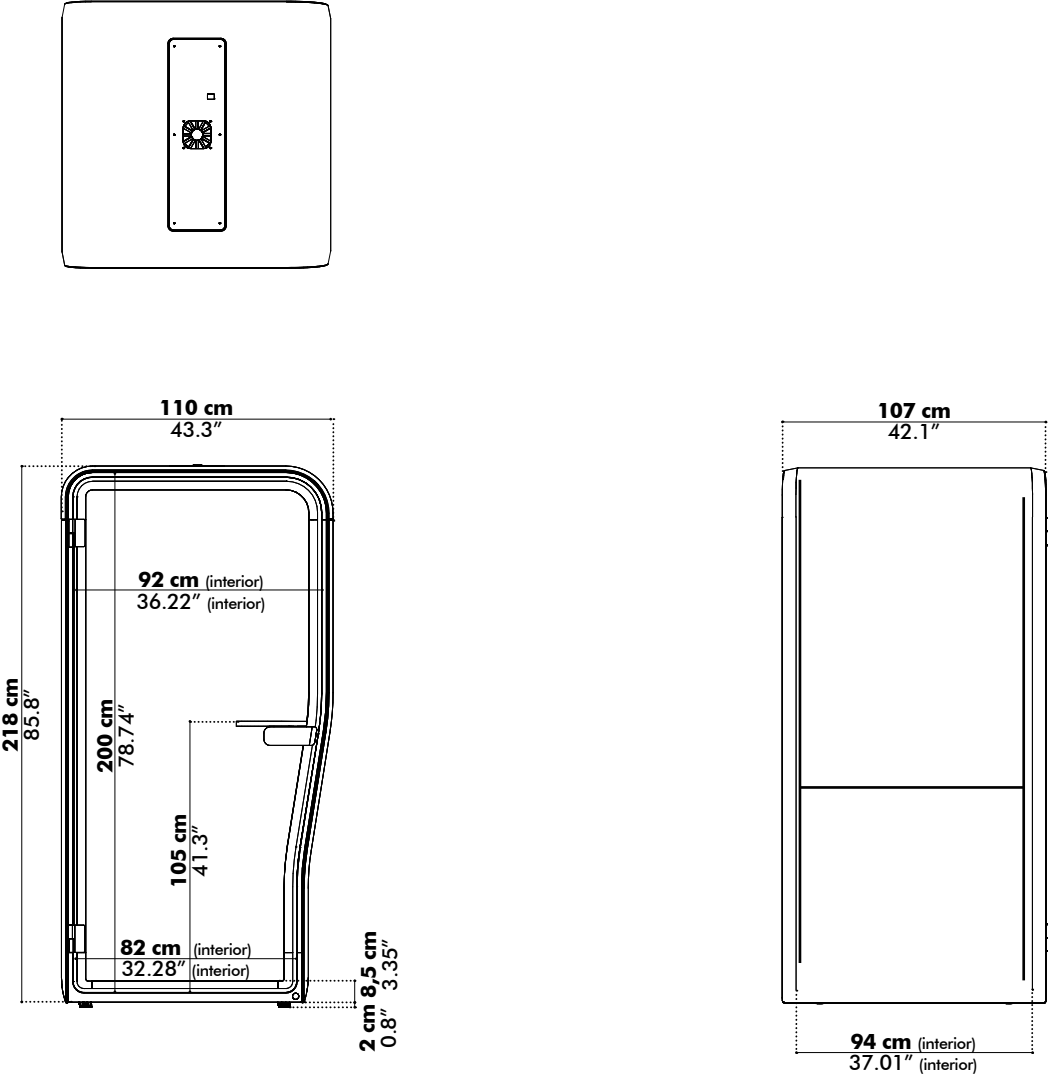

---

# Shelf

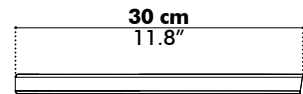
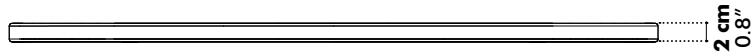
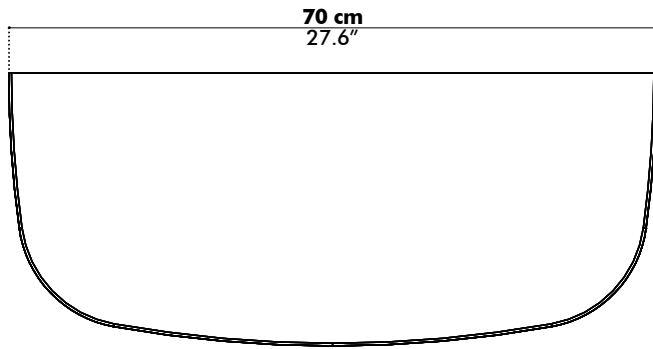

# Acoustics

## Sound blocker

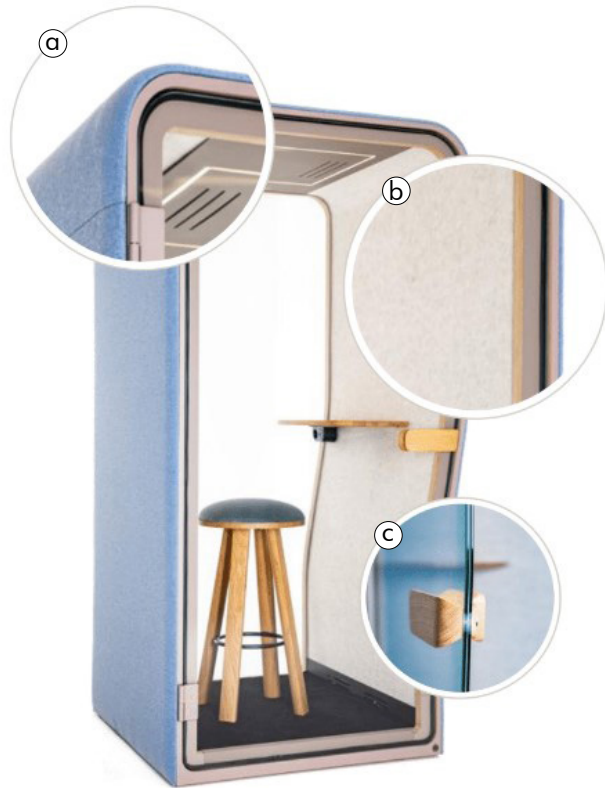

- a) Exterior: upholstered foam
- b) Interior: acoustic Felt or 3D Rib foam pattern
- c) Glass with acoustic foil

### Peace and quiet inside

27dB sound reduction, a conversation is turned into an indistinguishable whisper.

### Acoustic Principles

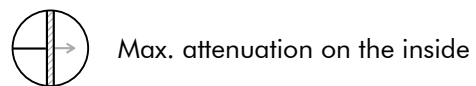

### High performer on all frequencies, especially speech frequencies



## Speech Level Reduction\*

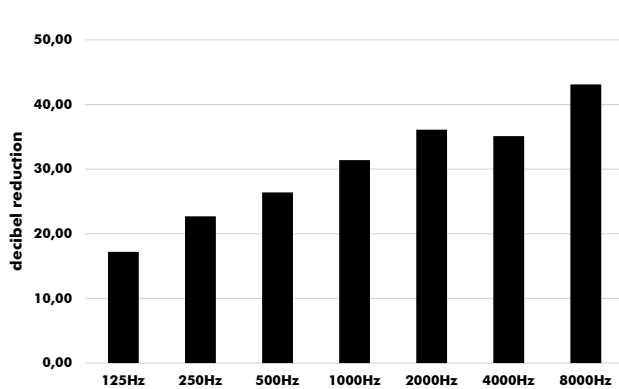

Hz	dB
125	17.2
250	22.7
500	26.4
1000	31.4
2000	36.1
4000	35.1
8000	43.1

Rating According to ISO 23351-1:2020  
Speech Level Reduction,  $D_{S,A} = 27.1$  dB

## Equivalent sound absorption area in m<sup>2</sup> per object\*

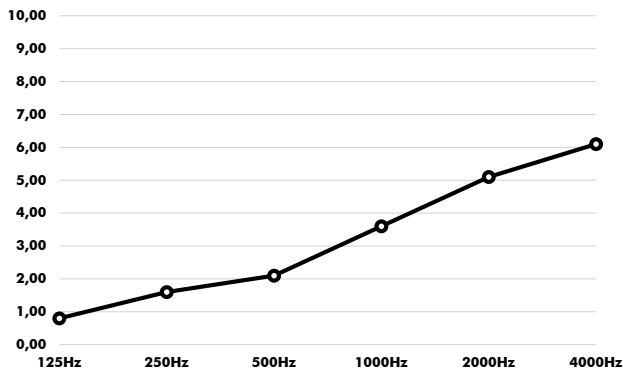

Hz	Aeq/m <sup>2</sup>
125	0.8
250	1.6
500	2.1
1000	3.6
2000	5.1
4000	6.1

\*Full test report available on our website