

a

by arturo alvarez

caos collection

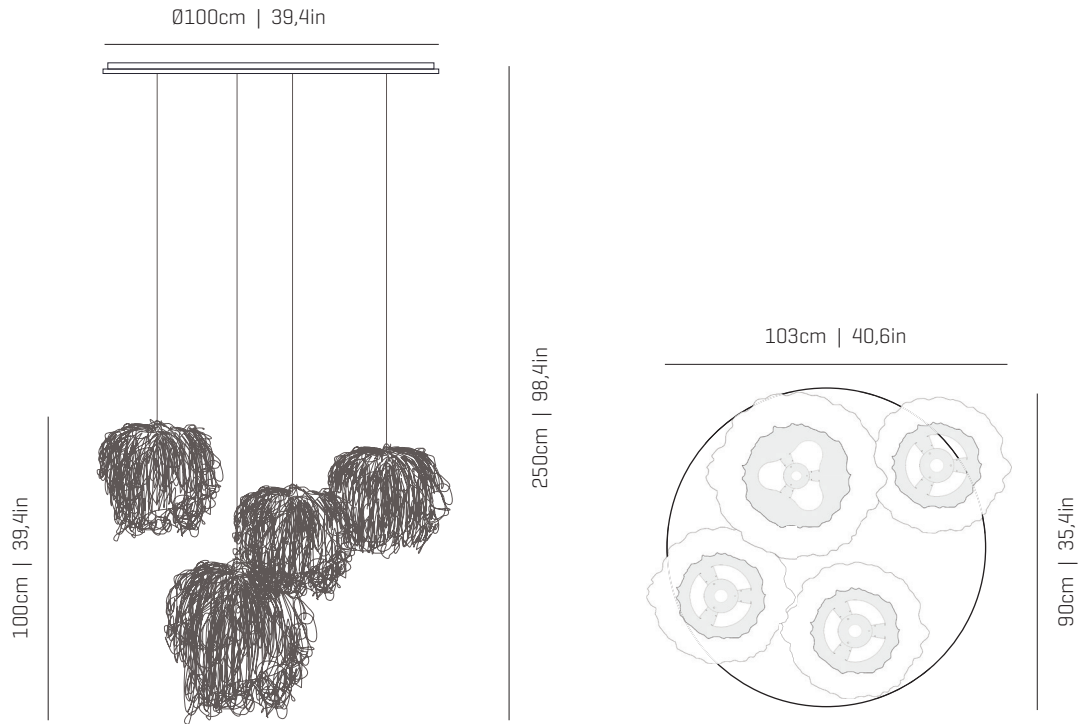

ref. CA04A-4



MATERIALS & COMPONENTS | MATERIALES & COMPONENTES

LAMPSHADE | TULIPA

Cord | One color to choose
Cordón | Un color a elegir



42 43 46 47 48



49 50 51 52

Color combinations upon request
Combinaciones de color bajo pedido

Stainless steel
Acero inoxidable

ref. 3xCA04A, 1xCA04AG

CANOPY AND CABLE | FLORÓN Y CABLE DIBOND®

Transparent or black cable
Cable transparente o negro

Length/largo customizable

RECOMMENDED BULBS BOMBILLAS RECOMENDADAS

230V - 50Hz

E27 LED Vintage - Max. 4x12 W

E27 LED Standard - Max. 4x12 W

120V - 60Hz

E26 LED - Max. 4x12 W

ENERGY EFFICIENCY EFICIENCIA ENERGÉTICA

from A++ to E
desde A++ a E

OTHER DATA | OTROS DATOS

NET WEIGHT | PESO NETO

7,7kg | 17,2lb

PACKAGING | EMBALAJE

80X120x115cm | 31,5x47,2x45,3in

18kg | 39,6lb

ELECTRICAL FEATURES CARACTERÍSTICAS ELÉCTRICAS



CERTIFICATIONS CERTIFICACIONES



by arturo alvarez

Caos

ref. CA04A - 4

Suitable for indoor use, at 25°C

Apta para uso interior a temperatura ambiente de 25°C

Box contains | Contenido de la caja:

- A** - Lampshade | Tulipas [4]
- B** - Canopy | Florón [1]
- C** - Frame | Soporte [1]
- D** - Cap | Tapón [3]
- E** - Screws | Tornillos [4]
- F** - Wall plug | Tacos [4]
- G** - Electrical disposal | Ficha conexión [1]

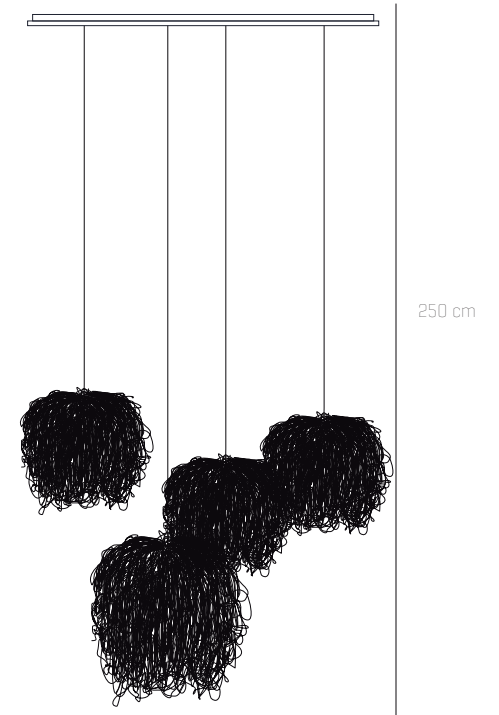
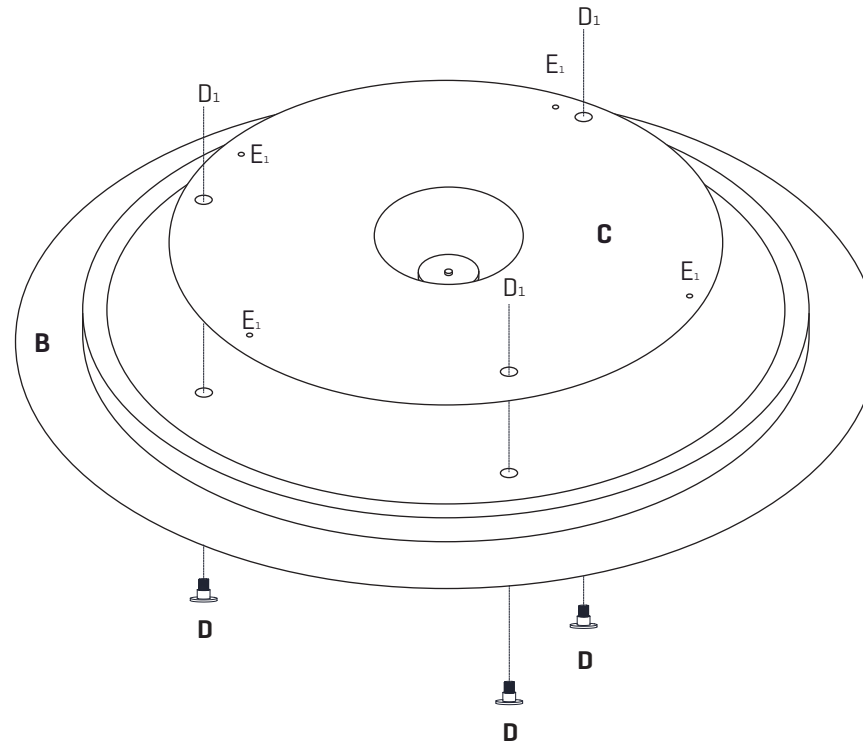

FRONTAL VIEW | VISTA FRONTAL

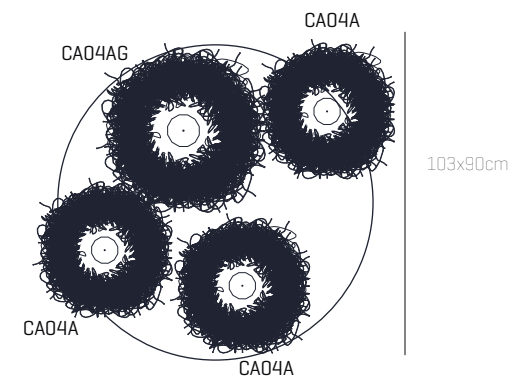
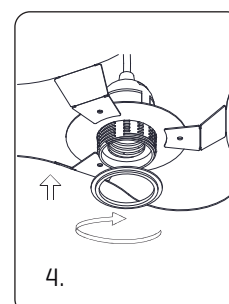
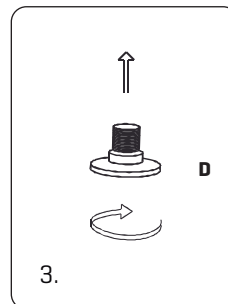
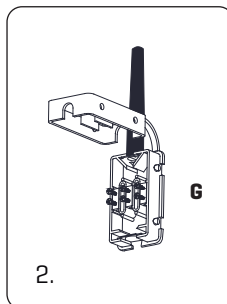
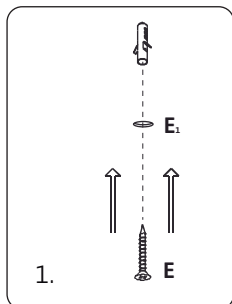

BOTTOM VIEW | VISTA INFERIOR
POSITION LAMP SHADES | POSICIÓN DE LAS TULIPAS

a

by arturo alvarez

ASSEMBLY INSTRUCTIONS
INSTRUCCIONES DE MONTAJE

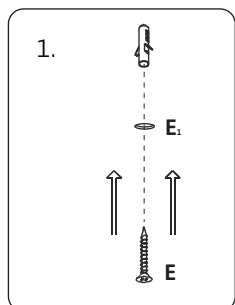

1. Make holes in the ceiling as marked in the frame with the letter E., insert the wall plugs and fix the frame.

* Our plugs are appropriate for concrete ceilings only

1. Hacer los taladros en su techo según los marcados en el soporte con la letra E., colocar los tacos y fijar el soporte.

* Nuestros tacos son sólo aptos para superficies de hormigón

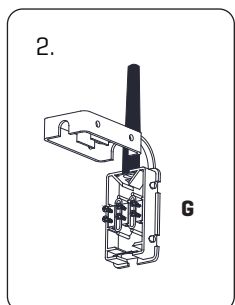

2. Pass the electrical wires inside the electrical disposal G.

The power cables from the wall shouldn't exceed the dimension of the black hose connection box provided, as shown in Fig. 2.1

Make the electrical connections taking care to respect the correct polarity as the color code.

2. Pasar los cables eléctricos al interior de la caja de conexiones G.

Los cables de alimentación procedentes de la pared no deben exceder la dimensión del manguito negro de la caja de conexiones suministrada, tal y como se indica en la figura 2.1

Realizar la conexión eléctrica teniendo cuidado de respetar la polaridad correcta según el código de colores.

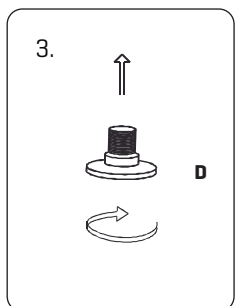
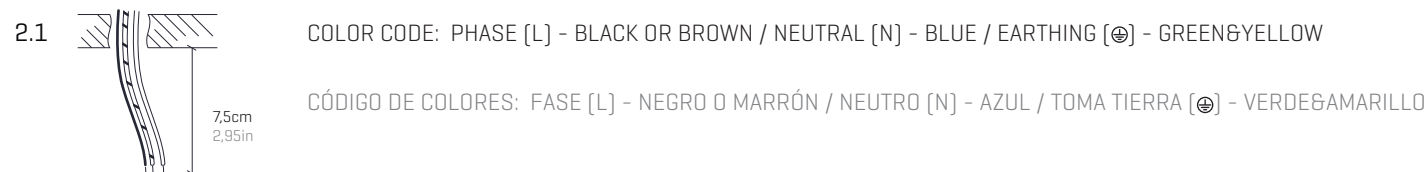

3. Once the frame is fixed, screw the caps in the holes marked with D.

3. Colocado el soporte, enroscar los tapones en los taladros marcados con la letra D.

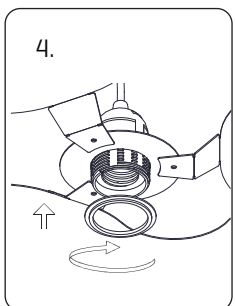

4. All the lampholder are marked with its appropriate lampshade [name].

Insert the lampshade into the lampholder and tighten the nut.

4. Todos los portalámparas están marcados con la tulipa correspondiente [nombre].

Encajar la tulipa en el portalámparas y apretar la tuerca.